

100V N-Channel Enhancement Mode MOSFET

Description

The APG110N10NF uses advanced **APM-SGT₁₁** technology to provide excellent $R_{DS(ON)}$, low gate charge and operation with gate voltages as low as 4.5V. This device is suitable for use as a Battery protection or in other Switching application.

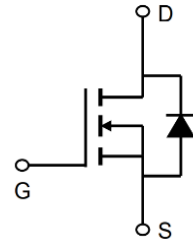

General Features

$V_{DS} = 100V$ $I_D = 110A$

$R_{DS(ON)} < 6m\Omega$ @ $V_{GS}=10V$ (Type: 4.2m Ω)

Application

DC/DC Converter

LED Backlighting

Power Management Switches

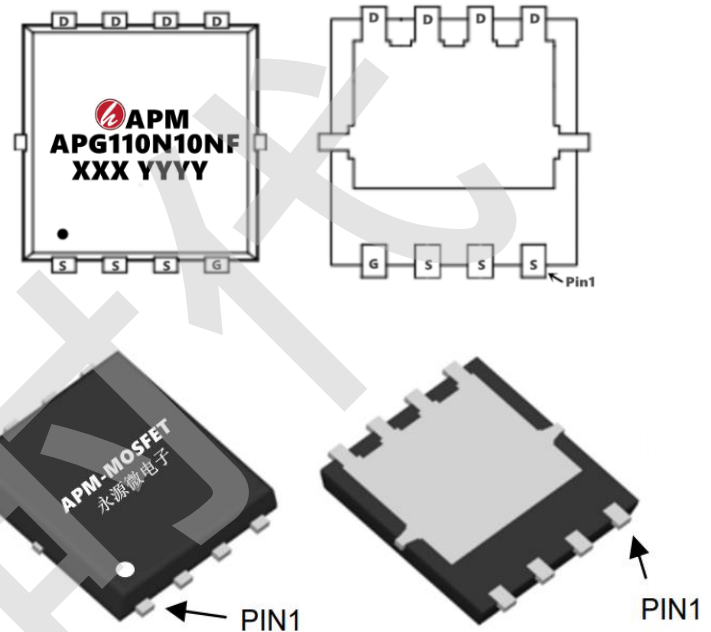

Package Marking and Ordering Information

Product ID	Pack	Marking	Qty(PCS)
APG110N10NF	PDFN5*6-8L	APG110N10NF XXX YYYY	5000

Absolute Maximum Ratings ($T_C=25^\circ\text{C}$ unless otherwise noted)

Symbol	Parameter	Value	Unit
VDS	Drain source voltage	100	V
VGS	Gate source voltage	± 20	V
ID	Continuous drain current, $T_C=25^\circ\text{C}$	110	A
IDM	Pulsed drain current, $T_C=25^\circ\text{C}$	380	A
PD	Power dissipation, $T_C=25^\circ\text{C}$	113.6	W
EAS	Single pulsed avalanche energy ⁴⁾	205	mJ
Tstg, Tj	Operation and storage temperature	-55 to 150	$^\circ\text{C}$
R θ JC	Thermal resistance, junction-case	1.1	$^\circ\text{C/W}$
R θ JA	Thermal resistance, junction-ambient ⁴⁾	58	$^\circ\text{C/W}$

100V N-Channel Enhancement Mode MOSFET

Electrical Characteristics (T_C=25°C unless otherwise noted)

Symbol	Parameter	Test Conditions	Min.	Typ.	Max.	Unit
VDSS	Drain-Source Breakdown Voltage	V _{GS} = 0V, I _D = 250μA	100	-	-	V
IGSS	Gate-body Leakage current	V _{DS} = 0V, V _{GS} = ±20V	-	-	±100	nA
IDSS	Zero Gate Voltage Drain Current T _J =25°C	V _{DS} = 100V, V _{GS} = 0V	-	-	1	μA
IDSS	Zero Gate Voltage Drain Current T _J =100°C		-	-	100	
VGS(th)	Gate-Threshold Voltage	V _{DS} = V _{GS} , I _D = 250μA	1.2	1.8	2.5	V
RDS(on)	Drain-Source on-Resistance ²	V _{GS} = 10V, I _D = 20A	-	4.2	6	mΩ
		V _{GS} = 4.5V, I _D = 15A	-	6.6	9	
Ciss	Input Capacitance	V _{DS} = 50V, V _{GS} = 0V, f = 1MHz	-	4400	-	pF
Coss	Output Capacitance		-	645	-	
Crss	Reverse Transfer Capacitance		-	20	-	
R _g	Gate Resistance	V _{GS} = 0V, V _{DS} = 0V, f = 1MHz	-	1.7	-	Ω
Q _g	Total Gate Charge	V _{GS} = 10V, V _{DS} = 50V, I _D = 20A	-	75	-	nC
Q _{gs}	Gate-Source Charge		-	17	-	
Q _{gd}	Gate-Drain Charge		-	13	-	
td(on)	Turn-on Delay Time	V _{GS} = 10V, V _{DS} = 50V, R _G = 3Ω, I _D = 20A	-	15.4	-	ns
t _r	Rise Time		-	13	-	
td(off)	Turn-off Delay Time		-	34	-	
t _f	Fall Time		-	6.2	-	
VSD	Diode Forward Voltage ²	I _F = 20A, V _{GS} = 0V	-	-	1.2	V
I _S	Continuous Source Current ^{1,5}	V _G =V _D =0V, Force Current	-	-	95	A
trr	Body Diode Reverse Recovery Time	I _F = 20A, dI/dt=100A/μs	-	55	-	ns
Q _{rr}	Body Diode Reverse Recovery Charge		-	101	-	nC

Notes:

- 1、The data tested by surface mounted on a 1 inch² FR-4 board with 2OZ copper.
- 2、The data tested by pulsed, pulse width ≤ 300us, duty cycle ≤ 2%
- 3、The EAS data shows Max. rating. The test condition is V_{DD}=50V, V_{GS}=10V, L=0.4mH, I_{AS}=32A
- 4、The power dissipation is limited by 150°C junction temperature
- 5、The data is theoretically the same as I_D and I_{DM}, in real applications, should be limited by total power dissipation.

Typical Characteristics

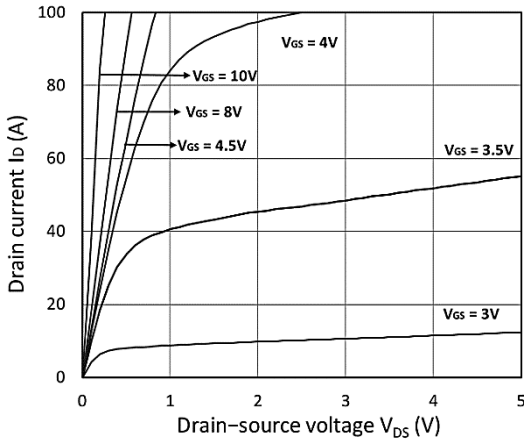

Figure 1. Output Characteristics

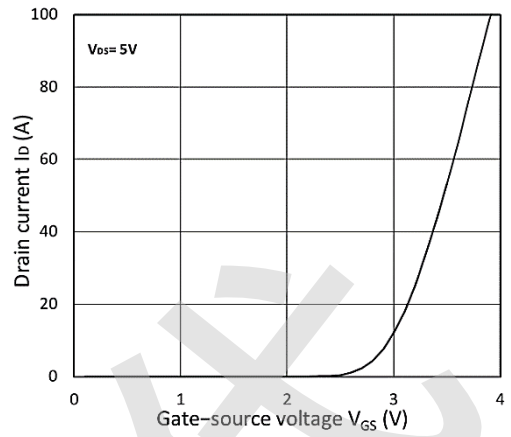

Figure 2. Transfer Characteristics

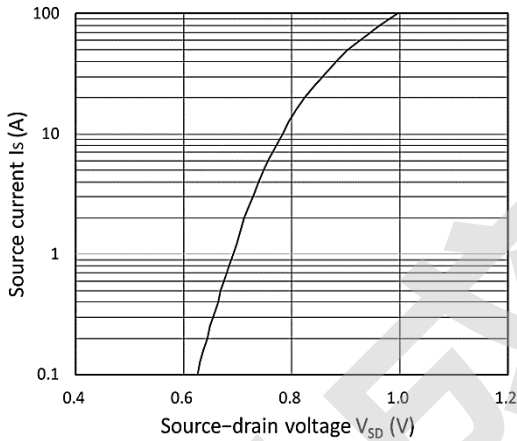

Figure 3. Forward Characteristics of Reverse

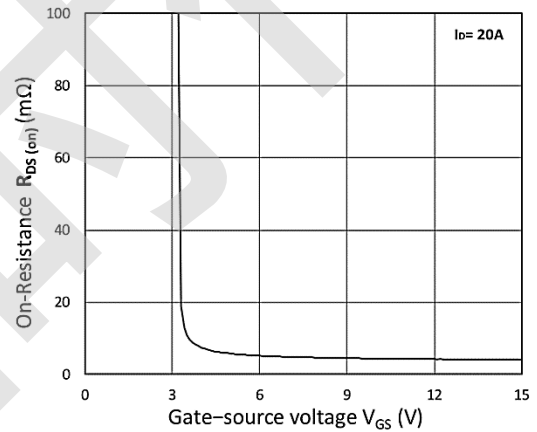

Figure 4. $R_{DS(ON)}$ vs. V_{GS}

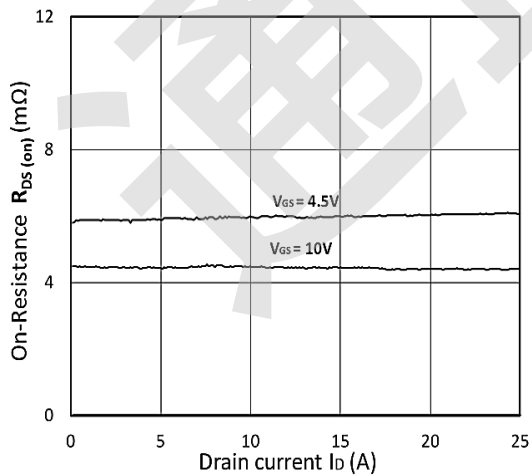

Figure 5. $R_{DS(ON)}$ vs. I_D

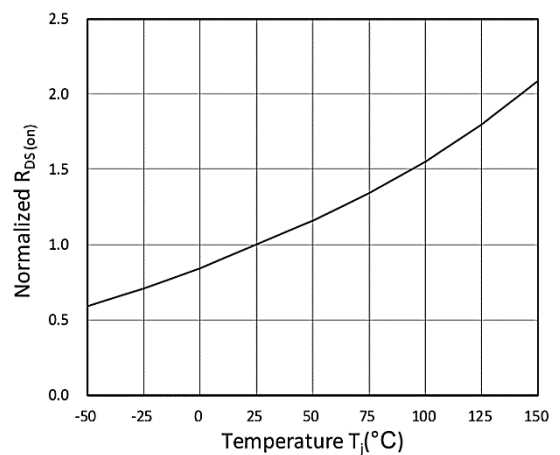

Figure 6. Normalized $R_{DS(on)}$ vs. Temperature

100V N-Channel Enhancement Mode MOSFET

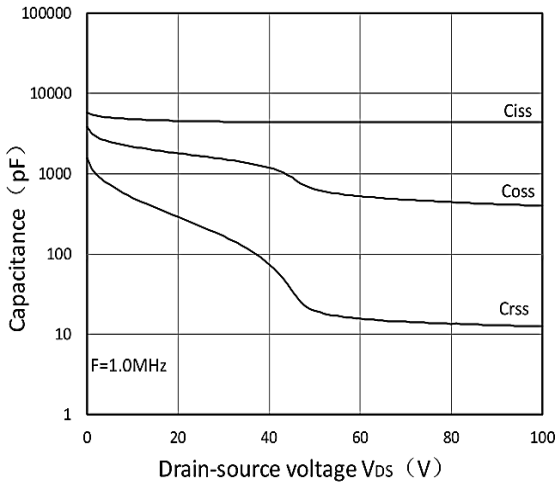

Figure 7. Capacitance Characteristics

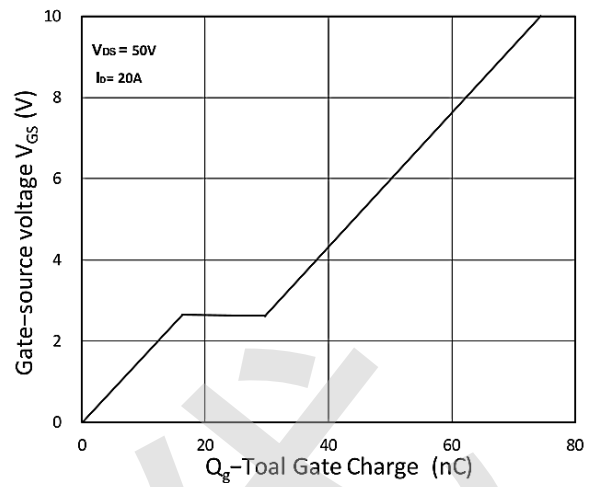

Figure 8. Gate Charge Characteristics

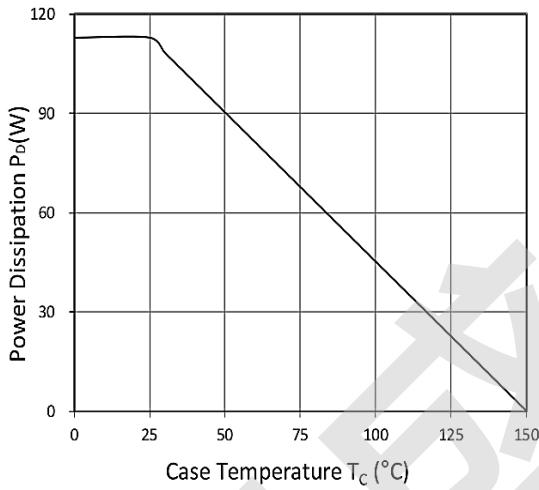

Figure 9. Power Dissipation

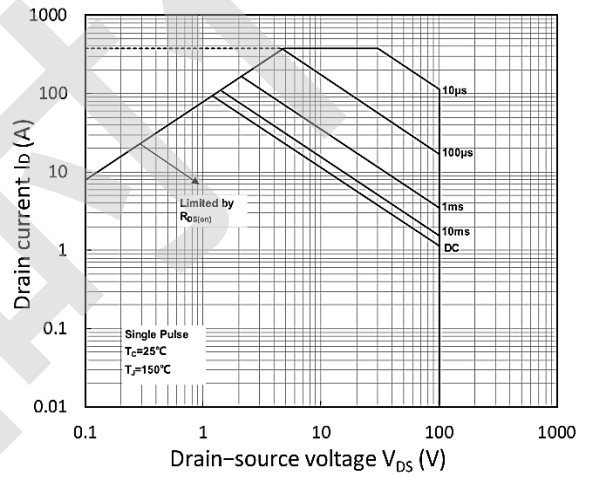

Figure 10. Safe Operating Area

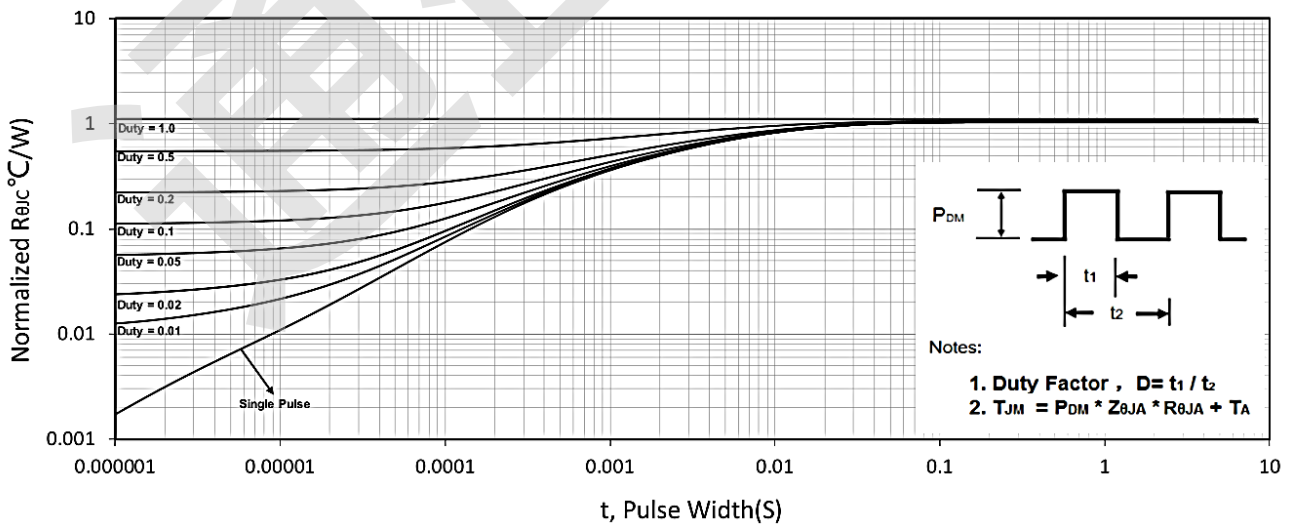
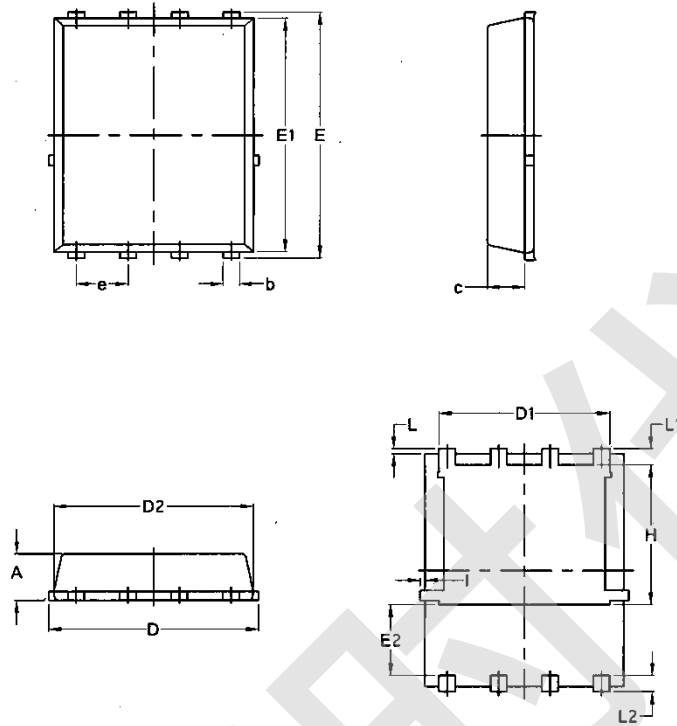

Figure 11. Normalized Maximum Transient Thermal Impedance

Package Mechanical Data-DFN5*6-8L-JQ Single



Symbol	Common			
	mm		Inch	
	Min	Max	Min	Max
A	1.03	1.17	0.0406	0.0461
b	0.34	0.48	0.0134	0.0189
c	0.824	0.0970	0.0324	0.082
D	4.80	5.40	0.1890	0.2126
D1	4.11	4.31	0.1618	0.1697
D2	4.80	5.00	0.1890	0.1969
E	5.95	6.15	0.2343	0.2421
E1	5.65	5.85	0.2224	0.2303
E2	1.60	/	0.0630	/
e	1.27 BSC		0.05 BSC	
L	0.05	0.25	0.0020	0.0098
L1	0.38	0.50	0.0150	0.0197
L2	0.38	0.50	0.0150	0.0197
H	3.30	3.50	0.1299	0.1378
I	/	0.18	/	0.0070

Attention

1, Any and all APM Microelectronics products described or contained herein do not have specifications that can handle applications that require extremely high levels of reliability, such as life support systems, aircraft's control systems, or other applications whose failure can be reasonably expected to result in serious physical and/or material damage. Consult with your APM Microelectronics representative nearest you before using any APM Microelectronics products described or contained herein in such applications.

2, APM Microelectronics assumes no responsibility for equipment failures that result from using products at values that exceed, even momentarily, rated values (such as maximum ratings, operating condition ranges, or other parameters) listed in products specifications of any and all APM Microelectronics products described or contained herein.

3, Specifications of any and all APM Microelectronics products described or contained here instipulate the performance, characteristics, and functions of the described products in the independent state, and are not guarantees of the performance, characteristics, and functions of the described products as mounted in the customer's products or equipment. To verify symptoms and states that cannot be evaluated in an independent device, the customer should always evaluate and test devices mounted in the customer's products or equipment.

4, APM Microelectronics Semiconductor CO., LTD. strives to supply high quality high reliability products. However, any and all semiconductor products fail with some probability. It is possible that these probabilistic failures could give rise to accidents or events that could endanger human lives that could give rise to smoke or fire, or that could cause damage to other property. When designing equipment, adopt safety measures so that these kinds of accidents or events cannot occur. Such measures include but are not limited to protective circuits and error prevention circuits for safe design, redundant design, and structural design.

5, In the event that any or all APM Microelectronics products (including technical data, services) described or contained herein are controlled under any of applicable local export control laws and regulations, such products must not be exported without obtaining the export license from the authorities concerned in accordance with the above law.

6, No part of this publication may be reproduced or transmitted in any form or by any means, electronic or mechanical, including photocopying and recording, or any information storage or retrieval system, or otherwise, without the prior written permission of APM Microelectronics Semiconductor CO., LTD.

7, Information (including circuit diagrams and circuit parameters) herein is for example only; it is not guaranteed for volume production. APM Microelectronics believes information herein is accurate and reliable, but no guarantees are made or implied regarding its use or any infringements of intellectual property rights or other rights of third parties.

8, Any and all information described or contained herein are subject to change without notice due to product/technology improvement, etc. When designing equipment, refer to the "Delivery Specification" for the APM Microelectronics product that you intend to use.

Edition	Date	Change
Rve1.0	2021/8/5	Initial release

Copyright Attribution“APM-Microelectronice”

通盛时代