

NCE N-Channel Enhancement Mode Power MOSFET

Description

The NCE1505S uses advanced trench technology and design to provide excellent $R_{DS(ON)}$ with low gate charge. It can be used in a wide variety of applications.

General Features

- $V_{DS} = 150V, I_D = 5.2A$
 $R_{DS(ON)} < 44m\Omega @ V_{GS}=10V$ (Typ: 31m Ω)
- High density cell design for ultra low R_{dson}
- Fully characterized avalanche voltage and current
- Low gate to drain charge to reduce switching losses

Application

- Power switching application
- Hard switched and high frequency circuits
- Uninterruptible power supply

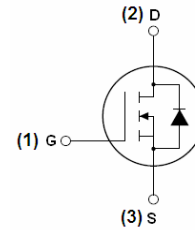

Schematic diagram



Marking and pin assignment

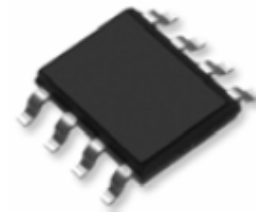

SOP-8 top view

Package Marking and Ordering Information

Device Marking	Device	Device Package	Reel Size	Tape width	Quantity
NCE1505S	NCE1505S	SOP-8	Ø330mm	12mm	4000 units

Absolute Maximum Ratings ($T_A=25^\circ C$ unless otherwise noted)

Parameter	Symbol	Limit	Unit
Drain-Source Voltage	V_{DS}	150	V
Gate-Source Voltage	V_{GS}	± 20	V
Drain Current-Continuous	I_D	5.2	A
Drain Current-Continuous($T_C=100^\circ C$)	$I_D(100^\circ C)$	3.7	A
Pulsed Drain Current(Note 1)	I_{DM}	42	A
Maximum Power Dissipation	P_D	3.5	W
Operating Junction and Storage Temperature Range	T_J, T_{STG}	-55 To 150	$^\circ C$

Thermal Characteristic

Thermal Resistance, Junction-to-Ambient ^{Note 2)}	$R_{\theta JA}$	35.7	$^\circ C/W$
--	-----------------	------	--------------

Electrical Characteristics (T_A=25°C unless otherwise noted)

Parameter	Symbol	Condition	Min	Typ	Max	Unit
Off Characteristics						
Drain-Source Breakdown Voltage	BV _{DSS}	V _{GS} =0V, I _D =250μA	150	170	-	V
Zero Gate Voltage Drain Current	I _{DSS}	V _{DS} =150V, V _{GS} =0V	-	-	1	μA
Gate-Body Leakage Current	I _{GSS}	V _{GS} =±20V, V _{DS} =0V	-	-	±100	nA
On Characteristics (Note 3)						
Gate Threshold Voltage	V _{GS(th)}	V _{DS} =V _{GS} , I _D =250μA	2.5	3.2	4.5	V
Drain-Source On-State Resistance	R _{DS(ON)}	V _{GS} =10V, I _D =5.2A	-	31	44	mΩ
Forward Transconductance	g _{FS}	V _{DS} =50V, I _D =5.2A	12	-	-	S
Dynamic Characteristics (Note 4)						
Input Capacitance	C _{iss}	V _{DS} =25V, V _{GS} =0V, F=1.0MHz	-	1700	-	PF
Output Capacitance	C _{oss}		-	190	-	PF
Reverse Transfer Capacitance	C _{rss}		-	90	-	PF
Switching Characteristics (Note 4)						
Turn-on Delay Time	t _{d(on)}	V _{DD} =75V, I _D =3.1A V _{GS} =10V, R _{GEN} =6.5Ω	-	15	-	nS
Turn-on Rise Time	t _r		-	13	-	nS
Turn-Off Delay Time	t _{d(off)}		-	26	-	nS
Turn-Off Fall Time	t _f		-	14	-	nS
Total Gate Charge	Q _g	V _{DS} =75V, I _D =3.1A, V _{GS} =10V	-	35.8	-	nC
Gate-Source Charge	Q _{gs}		-	7.5	-	nC
Gate-Drain Charge	Q _{gd}		-	13	-	nC
Drain-Source Diode Characteristics						
Diode Forward Voltage (Note 3)	V _{SD}	V _{GS} =0V, I _S =3.1A	-	-	1.2	V
Diode Forward Current (Note 2)	I _S		-	-	2.7	A
Reverse Recovery Time	t _{rr}	T _J = 25°C, I _F = 3.1A, di/dt = 100A/μs	-	50	-	nS
Reverse Recovery Charge	Q _{rr}		-	140	-	nC

Notes:

1. Repetitive Rating: Pulse width limited by maximum junction temperature.
2. Surface Mounted on FR4 Board, t ≤ 10 sec.
3. Pulse Test: Pulse Width ≤ 300μs, Duty Cycle ≤ 2%.
4. Guaranteed by design, not subject to production.

Test Circuit

1) E_{AS} test Circuits

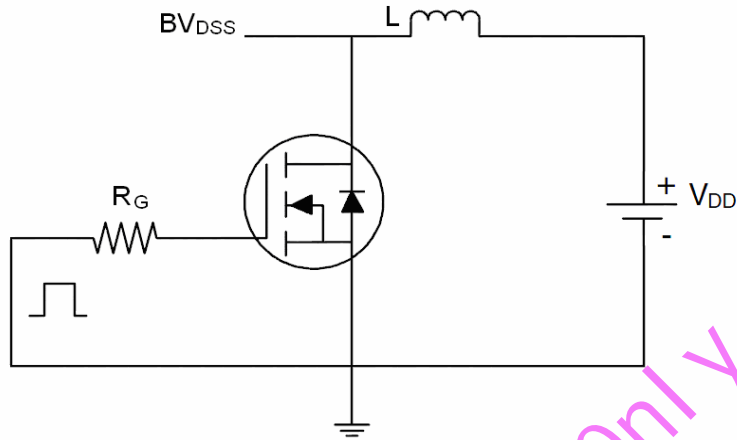

2) Gate charge test Circuit

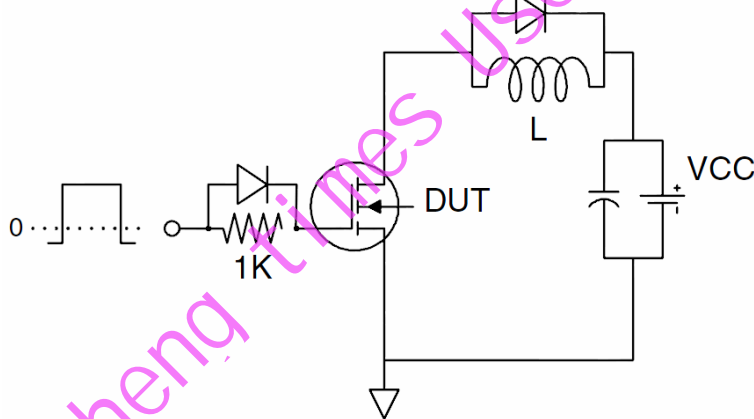

3) Switch Time Test Circuit

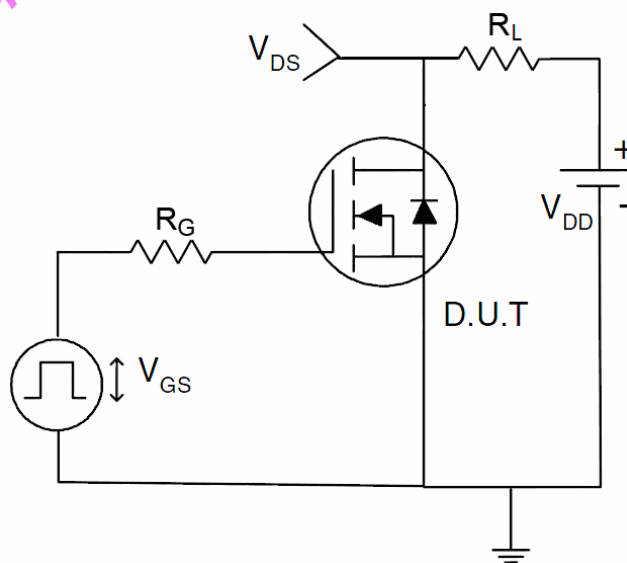

For Tongsheng Times Use Only

Typical Electrical and Thermal Characteristics (Curves)

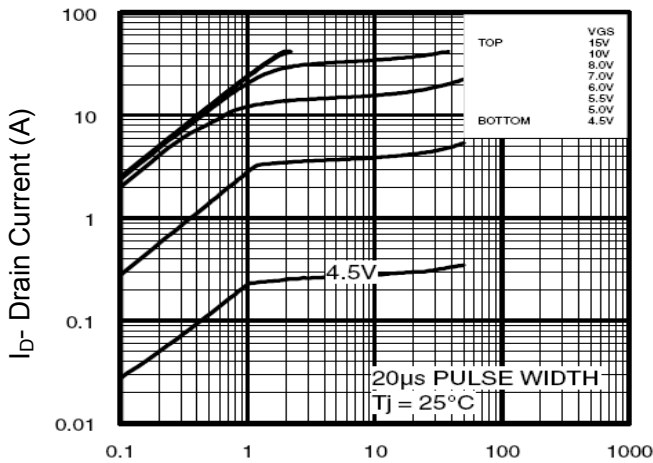

Vds Drain-Source Voltage (V)
Figure 1 Output Characteristics

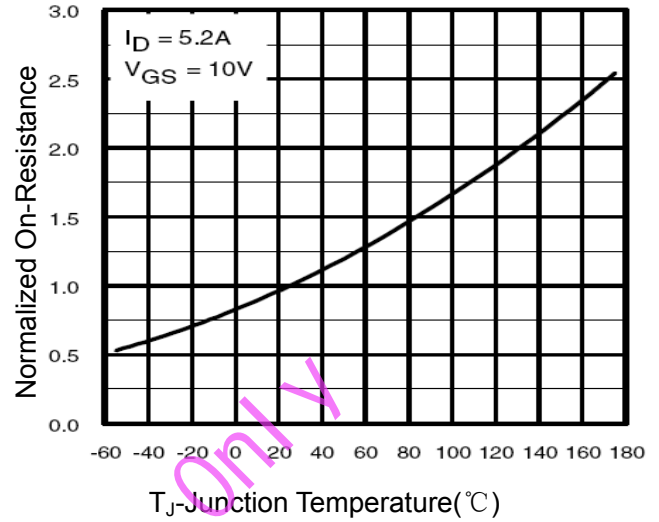

T_J -Junction Temperature($^\circ C$)
Figure 4 Rdson-Junction Temperature

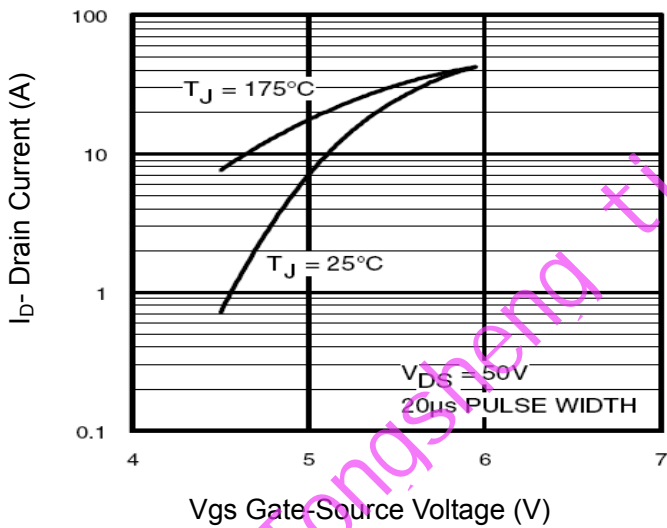

Vgs Gate-Source Voltage (V)
Figure 2 Transfer Characteristics

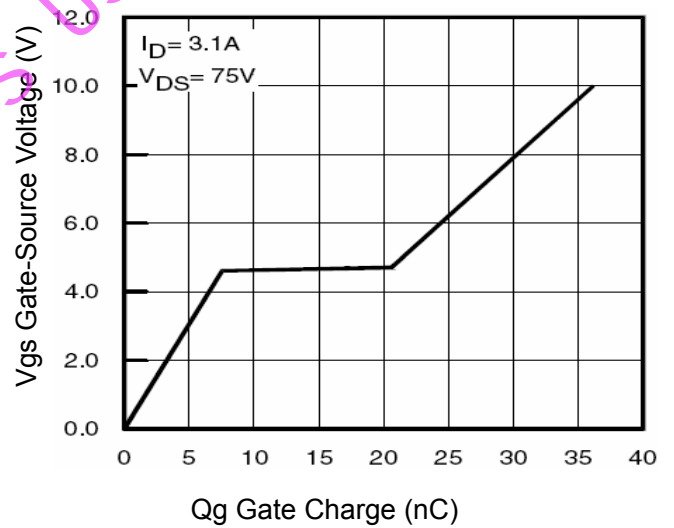

Qg Gate Charge (nC)
Figure 5 Gate Charge

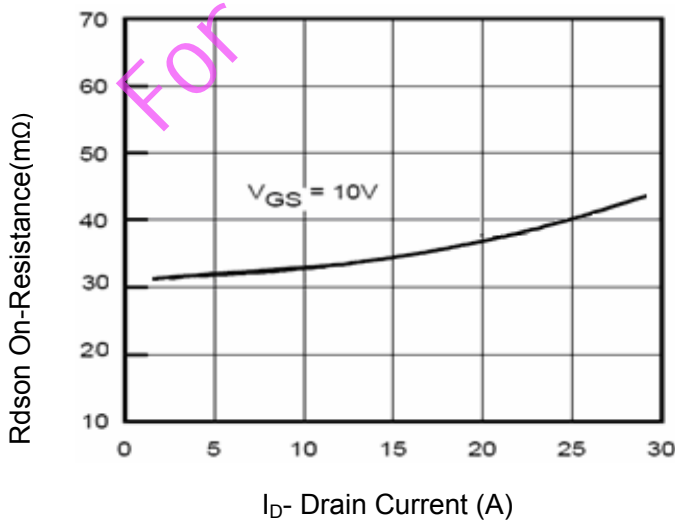

I_D - Drain Current (A)
Figure 3 Rdson- Drain Current

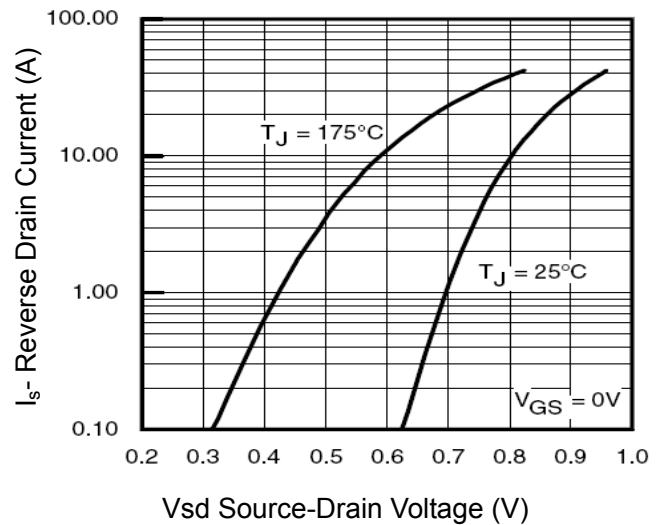

Vsd Source-Drain Voltage (V)
Figure 6 Source- Drain Diode Forward

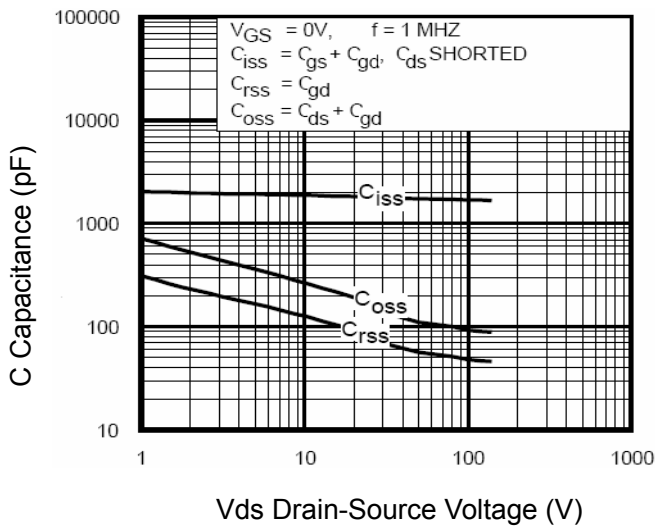

Figure 7 Capacitance vs Vds

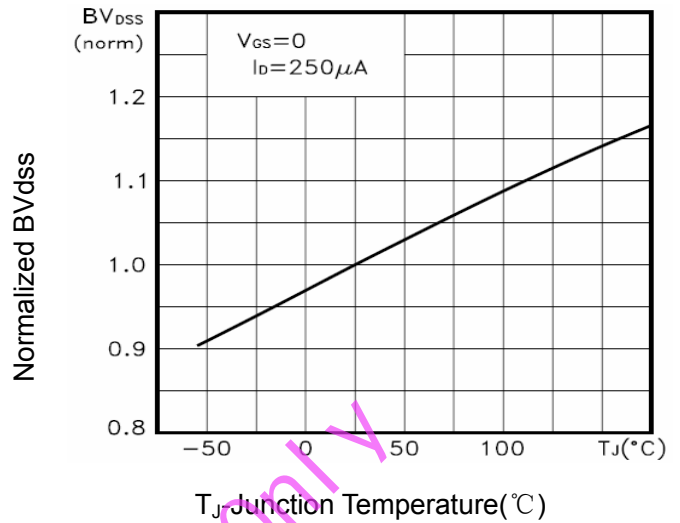

Figure 9 BV_{DSS} vs Junction Temperature

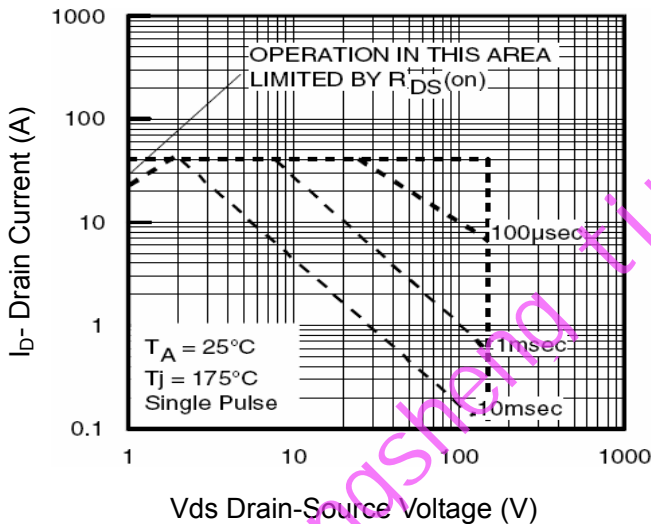

Figure 8 Safe Operation Area

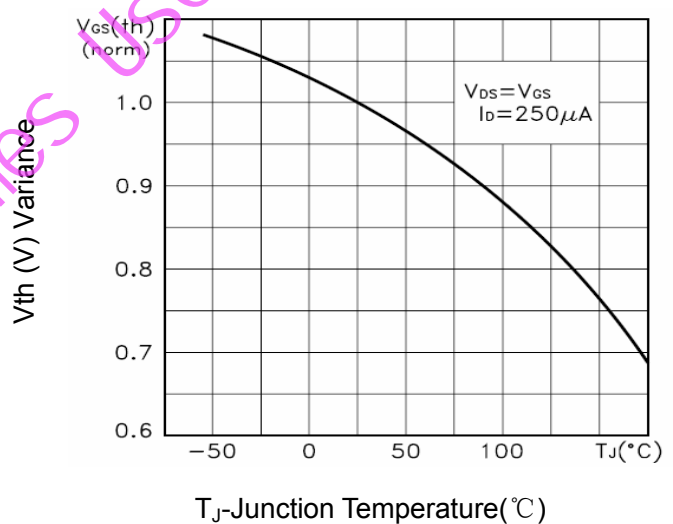

Figure 10 V_{GS(th)} vs Junction Temperature

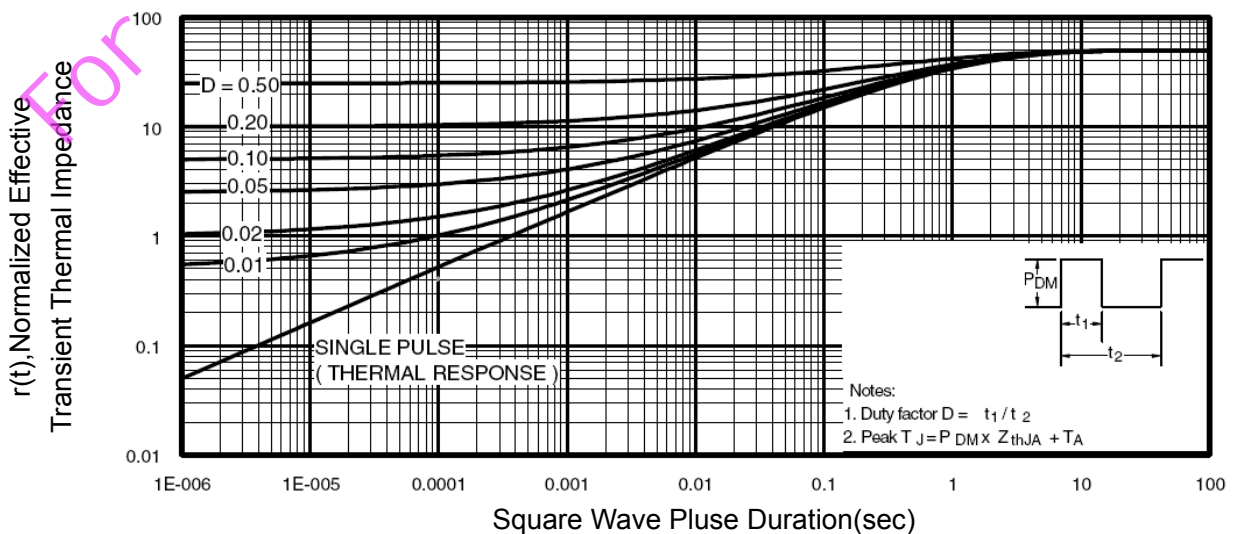
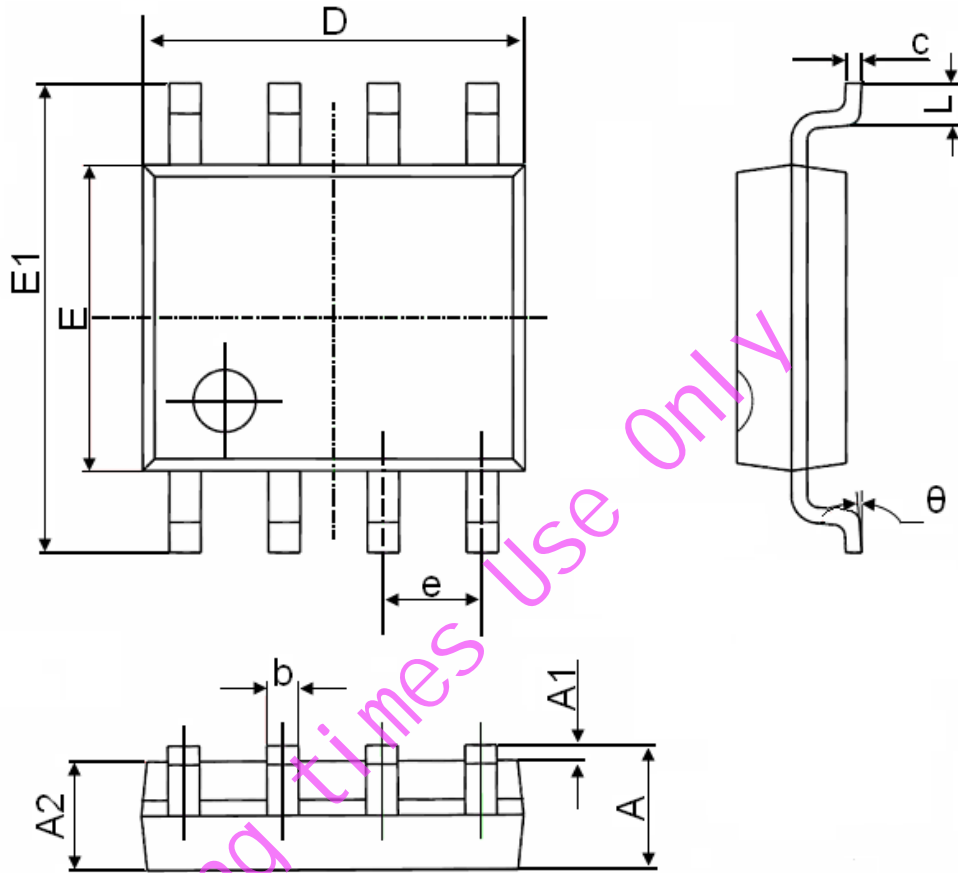

Figure 11 Normalized Maximum Transient Thermal Impedance

SOP-8 Package Information

Symbol	Dimensions In Millimeters		Dimensions In Inches	
	Min.	Max.	Min.	Max.
A	1.350	1.750	0.053	0.069
A1	0.100	0.250	0.004	0.010
A2	1.350	1.550	0.053	0.061
b	0.330	0.510	0.013	0.020
c	0.170	0.250	0.006	0.010
D	4.700	5.100	0.185	0.200
E	3.800	4.000	0.150	0.157
E1	5.800	6.200	0.228	0.244
e	1.270(BSC)		0.050(BSC)	
L	0.400	1.270	0.016	0.050
theta	0°	8°	0°	8°

Attention:

- Any and all NCE power products described or contained herein do not have specifications that can handle applications that require extremely high levels of reliability, such as life-support systems, aircraft's control systems, or other applications whose failure can be reasonably expected to result in serious physical and/or material damage. Consult with your NCE power representative nearest you before using any NCE power products described or contained herein in such applications.
- NCE power assumes no responsibility for equipment failures that result from using products at values that exceed, even momentarily, rated values (such as maximum ratings, operating condition ranges, or other parameters) listed in products specifications of any and all NCE power products described or contained herein.
- Specifications of any and all NCE power products described or contained herein stipulate the performance, characteristics, and functions of the described products in the independent state, and are not guarantees of the performance, characteristics, and functions of the described products as mounted in the customer's products or equipment. To verify symptoms and states that cannot be evaluated in an independent device, the customer should always evaluate and test devices mounted in the customer's products or equipment.
- NCE power Semiconductor CO.,LTD. strives to supply high-quality high-reliability products. However, any and all semiconductor products fail with some probability. It is possible that these probabilistic failures could give rise to accidents or events that could endanger human lives, that could give rise to smoke or fire, or that could cause damage to other property. When designing equipment, adopt safety measures so that these kinds of accidents or events cannot occur. Such measures include but are not limited to protective circuits and error prevention circuits for safe design, redundant design, and structural design.
- In the event that any or all NCE power products(including technical data, services) described or contained herein are controlled under any of applicable local export control laws and regulations, such products must not be exported without obtaining the export license from the authorities concerned in accordance with the above law.
- No part of this publication may be reproduced or transmitted in any form or by any means, electronic or mechanical, including photocopying and recording, or any information storage or retrieval system, or otherwise, without the prior written permission of NCE power Semiconductor CO.,LTD.
- Information (including circuit diagrams and circuit parameters) herein is for example only ; it is not guaranteed for volume production. NCE power believes information herein is accurate and reliable, but no guarantees are made or implied regarding its use or any infringements of intellectual property rights or other rights of third parties.
- Any and all information described or contained herein are subject to change without notice due to product/technology improvement, etc. When designing equipment, refer to the "Delivery Specification" for the NCE power product that you intend to use.
- This catalog provides information as of Sep.2010. Specifications and information herein are subject to change without notice.